

**alrouf**  
LIGHTING TECHNOLOGY CO.Ltd.



**شركة الروف**  
لتقنية الإنارة المحدودة

# EMERGENCY LIGHTING



2023  
NEW  
CATALOGUE

[www.alroufled.com](http://www.alroufled.com)

# EMERGENCY BULKHEAD

BY-Z2410E

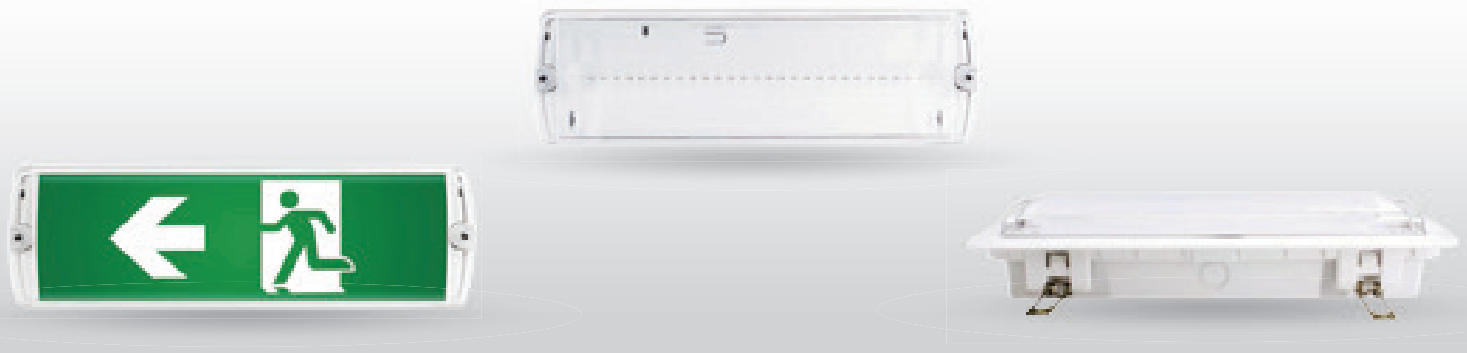

## Features

- » Super bright&Long Lasting LEDs
- » CE Approved
- » 3 Hour Emergency Duration
- » IP65 High Protection Level
- » Surface & Recessed Mounting (Optional)
- » Exit Sticker available (Optional)

## Different directions (customizable pattern)

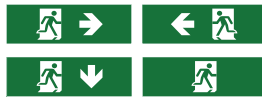

## Light Distribution Curve

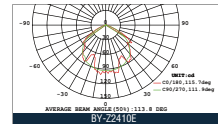

## Product Size

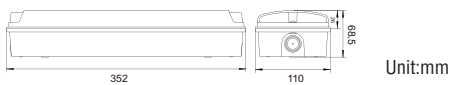

## Recessed mount kit Dimensions

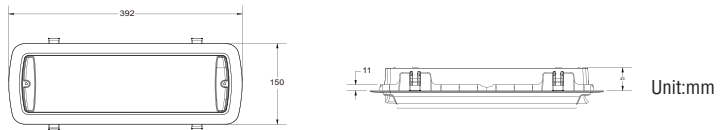

## Product parameters

MODEL NAME	BY-Z2410E
Input Voltage	AC120-277V, AC/50-60Hz
Light Source	SMD 2835 (50pcs)
Input Power	8.5W
Emergency Power	2W
Operation Mode	Maintained/Non-Maintained
Emergency Duration	180 Minutes
Emergency Luminance Flux	≥250lm
Recharge Time	24 Hrs
Battery	Ni-Cd 3.6V, 2000mAh
Battery Life	Up to 4 years
Operation Temp Range	0 °C -40°C
IP Rating	IP65
Auto Test	No

# EMERGENCY DOWN LIGHT

BY-T1006E1



## Features

- » Super bright LEDs
- » Surface/Recessed Mounting available
- » Two lens (Open area & Corridor Lens)
- » 300LM High output
- » TUV CE Approved

## Light Distribution Curve

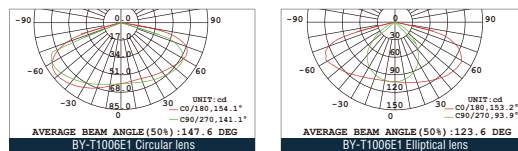

## Product Size

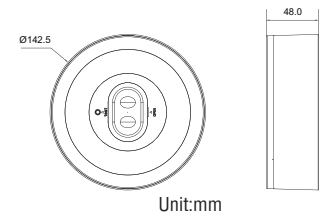

## Product parameters

MODEL NAME	BY-T1006E1
Input Voltage	AC 220-240V, 50/60Hz
Light Source	SMD3535 (2pcs)
Input Power	6W
Emergency Power	3W
Operation Mode	Non-Maintained
Emergency Duration	150 Minutes
Emergency Luminance Flux	300lm
Recharge Time	24 Hrs
Battery	Lithium 3.7V, 2200mAh
Battery Life	Up to 4 years
Operation Temp Range	0 °C -40°C
IP Rating	IP20
Auto Test	Yes

# EMERGENCY DOWN LIGHT

BY-Z1103S&BY-Z1105S&  
BY-Z1003S&BY-Z1005S

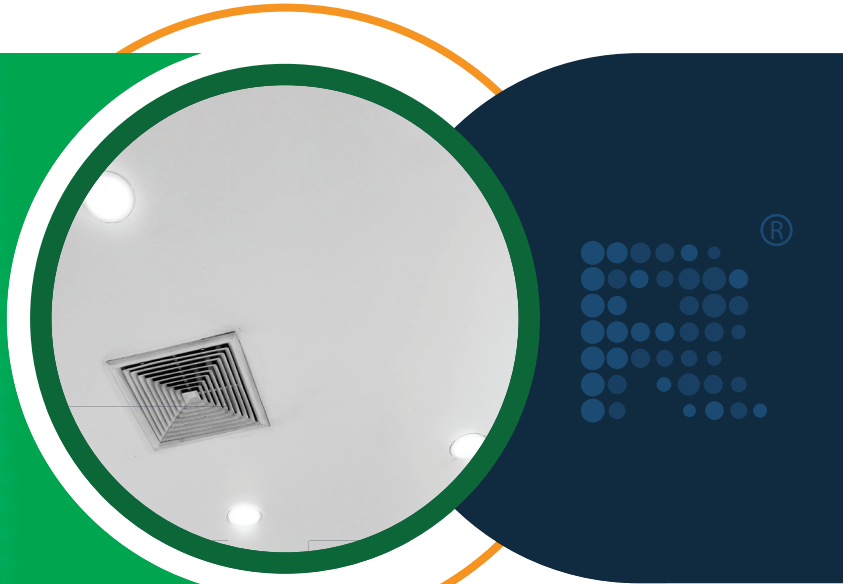

## Features

- » TUV CE Approved
- » LiFePO4 Battery, Lifespan up to 4 Years
- » Auto Test Function, Maintenance Saving
- » Overcharge&Over-discharge protection
- » 150/250LM Optional

## Light Distribution Curve

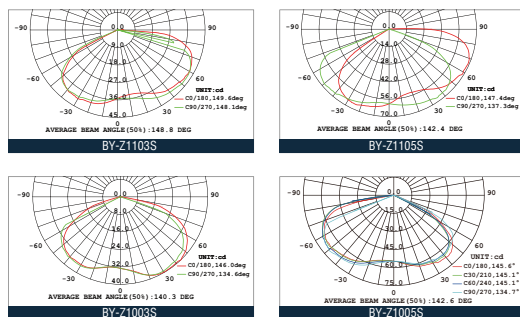

## Product Size

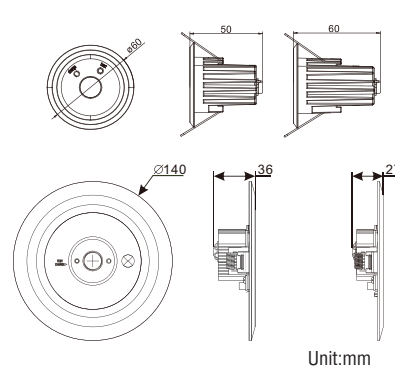

Unit:mm

## Product parameters

MODEL NAME	BY-Z1103S	BY-Z1105S	BY-Z1003S	BY-Z1005S
Input Voltage	AC 220-240V,50/60Hz	AC 220-240V,50/60Hz	AC 220-240V,50/60Hz	AC 220-240V,50/60Hz
Light Source	SMD 3535 (1pc)	SMD 3535 (1pc)	SMD 3535 (1pc)	SMD 3535 (1pc)
Input Power	3.5W	5.5W	3.5W	5.5W
Emergency Power	1.5W	2.5W	1.5W	2.5W
Operation Mode	Non-Maintained / Maintained	Non-Maintained / Maintained	Non-Maintained / Maintained	Non-Maintained / Maintained
Emergency Duration	180 Minutes	180 Minutes	180 Minutes	180 Minutes
Emergency Luminance Flux	150lm	250lm	150lm	250lm
Recharge Time	24 Hrs	24 Hrs	24 Hrs	24 Hrs
Battery	LiFePO4 3.2V 1500mAh	LiFePO4 3.2V 3000mAh	LiFePO4 3.2V 1500mAh	LiFePO4 3.2V 3000mAh
Battery Life	/	/	/	/
Operation Temp Range	0 °C -40°C	0 °C -40°C	0 °C -40°C	0 °C -40°C
IP Rating	IP20	IP20	IP20	IP20
Auto Test	Yes	Yes	Yes	Yes

# EMERGENCY DOWN LIGHT

BY-Z1603S&BY-Z1803S



## Features

- » TUV CE Approved
- » LiFePO4/Lithium Optional
- » Auto Test Function, Maintenance Saving
- » Overcharge&Over-discharge protection

## Light Distribution Curve

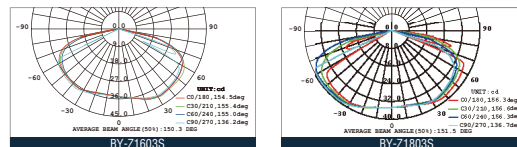

## Product Size

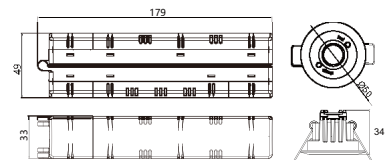

## Product parameters

MODEL NAME	BY-Z1603S	BY-Z1803S
Input Voltage	AC 220-240V,50/60Hz	AC 220-240V,50/60Hz
Light Source	SMD 3535 (1pc)	SMD 3535 (1pc)
Input Power	3W	3W
Emergency Power	1.5W	1.5W
Operation Mode	Non-Maintained	Non-Maintained
Emergency Duration	180 Minutes	180 Minutes
Emergency Luminance Flux	150lm	150lm
Recharge Time	24 Hrs	24 Hrs
Battery	LiFePO4 3.2V 1500mAh	Lithium 3.7V 1500mAh
Battery Life	/	/
Operation Temp Range	0 °C -40°C	0 °C -40°C
IP Rating	IP20	IP20
Auto Test	Yes	Yes

# EMERGENCY DOWN LIGHT

BY-Z1703S&BY-Z1706S

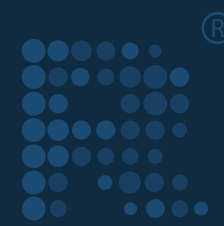

## Features

- » TUV CE Approved
- » Lithium Battery
- » Auto Test Function, Maintenance Saving
- » Overcharge&Over-discharge protection

## Light Distribution Curve

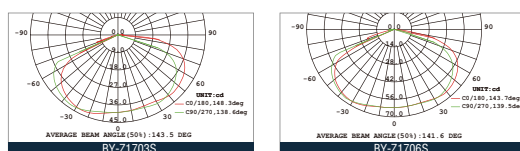

## Product Size

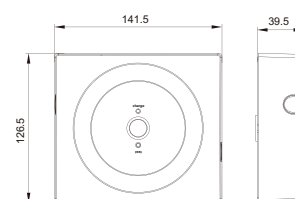

Unit:mm

## Product parameters

MODEL NAME	BY-Z1703S	BY-Z1706S
Input Voltage	AC 220-240V,50/60Hz	AC 220-240V,50/60Hz
Light Source	SMD 3535 (1pc)	SMD 3535 (2pcs)
Input Power	3W	6W
Emergency Power	1.5W	2.5W
Operation Mode	Non-Maintained	Non-Maintained
Emergency Duration	180 Minutes	180 Minutes
Emergency Luminance Flux	150lm	250lm
Recharge Time	24 Hrs	24 Hrs
Battery	Lithium 3.7V 1500mAh	Lithium 3.7V 3000mAh
Battery Life	/	/
Operation Temp Range	0 °C -40 °C	0 °C -40 °C
IP Rating	IP20	IP20
Auto Test	Yes	Yes

# EMERGENCY DOWN LIGHT

BY-Z-NI-2003S&BY-Z-NI-2005S

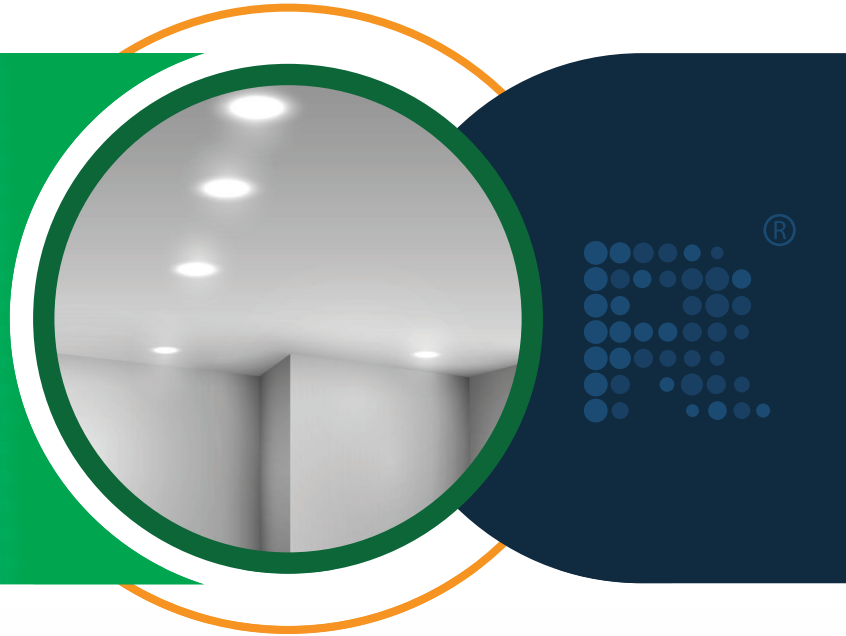

## Features

- » TUV CE Approved
- » LiFePO4 Battery, Lifespan up to 4Years
- » Auto Test Function, Maintenance Saving
- » Overcharge&Over-discharge protection
- » 150/250LM Optional

## Light Distribution Curve

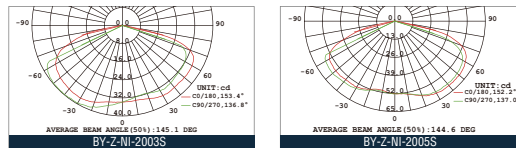

## Product Size

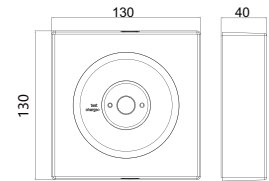

Unit:mm

## Product parameters

MODEL NAME	BY-Z-NI-2003S	BY-Z-NI-2005S
Input Voltage	AC 220-240V,50/60Hz	AC 220-240V,50/60Hz
Light Source	SMD 3535 (1pc)	SMD 3535 (1pc)
Input Power	3W	5W
Emergency Power	1.5W	3W
Operation Mode	Non-Maintained	Non-Maintained
Emergency Duration	180 Minutes	180 Minutes
Emergency Luminance Flux	150lm	250lm
Recharge Time	24 Hrs	24 Hrs
Battery	LiFePO4 3.2V 1500mAh	LiFePO4 3.2V 3000mAh
Battery Life	/	/
Operation Temp Range	0 °C -40°C	0 °C -40°C
IP Rating	IP20	IP20
Auto Test	Yes	Yes

# EMERGENCY DOWN LIGHT

BY-T1703E1&BY-T1703E2  
BY-T1706E1&BY-T1706E2



## Features

- » TUV CE Approved
- » Lithium Battery
- » Auto Test Function, Maintenance Saving
- » Overcharge&Over-discharge protection

## Product Size

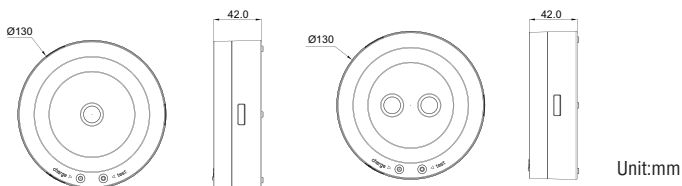

## Product parameters

MODEL NAME	BY-T1703E1	BY-T1703E2	BY-T1706E1	BY-T1706E2
<b>Input Voltage</b>	AC 220-240V,50/60Hz	AC 220-240V,50/60Hz	AC 220-240V,50/60Hz	AC 220-240V,50/60Hz
<b>Light Source</b>	SMD 3535 (1pc)	SMD 3535 (1pc)	SMD 3535 (2pcs)	SMD 3535 (2pcs)
<b>Input Power</b>	3W	3W	6W	6W
<b>Emergency Power</b>	1.5W	1.5W	2.5W	2.5W
<b>Operation Mode</b>	Non-Maintained	Non-Maintained	Non-Maintained	Non-Maintained
<b>Emergency Duration</b>	180 Minutes	180 Minutes	180 Minutes	180 Minutes
<b>Emergency Luminance Flux</b>	150lm	150lm	250lm	250lm
<b>Recharge Time</b>	24 Hrs	24 Hrs	24 Hrs	24 Hrs
<b>Battery</b>	Lithium 3.7V 1500mAh	LiFePO4 3.2V 1500mAh	Lithium 3.7V 3000mAh	LiFePO4 3.2V 3000mAh
<b>Battery Life</b>	/	/	/	/
<b>Operation Temp Range</b>	0 °C -40°C	0 °C -40°C	0 °C -40°C	0 °C -40°C
<b>IP Rating</b>	IP20	IP20	IP20	IP20
<b>Auto Test</b>	Yes	Yes	Yes	Yes



# EMERGENCY DOWN LIGHT

BY-T1403S&BY-T1405S



## Features

- » TUV CE Approved
- » LiFePO4 Battery, Lifespan up to 4Years
- » Auto Test Function, Maintenance Saving
- » Overcharge&Over-discharge protection
- » 1150/250LM Optional
- » IP54 High Rating, Can be use outdoor

## Light Distribution Curve

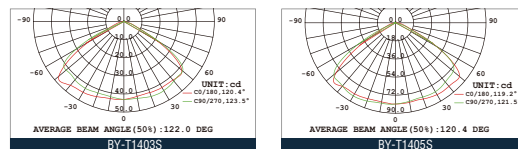

## Product Size

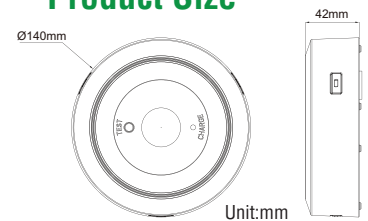

## Product parameters

MODEL NAME	BY-T1403S	BY-T1405S
Input Voltage	AC 220-240V,50/60Hz	AC 220-240V,50/60Hz
Light Source	SMD 3535 (1pc)	SMD 3535 (1pc)
Input Power	3W	5W
Emergency Power	1.5W	2.5W
Operation Mode	Non-Maintained	Non-Maintained
Emergency Duration	180 Minutes	180 Minutes
Emergency Luminance Flux	150lm	250lm
Recharge Time	24 Hrs	24 Hrs
Battery	LiFePO4 3.2V 1500mAh	LiFePO4 3.2V 3000mAh
Operation Temp Range	0 °C -40°C	0 °C -40°C
IP Rating	IP54	IP54
Auto Test	Yes	Yes
IK Rating	IK08	IK08

# EMERGENCY DOWN LIGHT

BY-T1003E



## Features

- » TUV CE Approved
- » Lithium Battery
- » Auto Test Function, Maintenance Saving
- » Overcharge & Over-discharge protection

## Light Distribution Curve

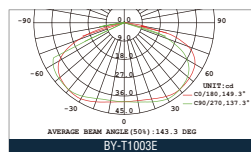

## Product Size

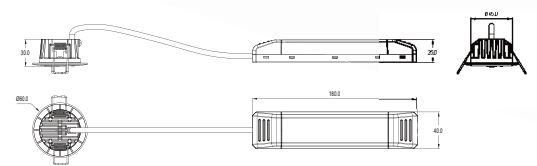

Unit:mm

## Product parameters

MODEL NAME	BY-T1003E
Input Voltage	AC 220-240V,50/60Hz
Light Source	SMD 3535 (1pc)
Input Power	3W
Emergency Power	1.5W
Operation Mode	Non-Maintained
Emergency Duration	180 Minutes
Emergency Luminance Flux	150lm
Recharge Time	24 Hrs
Battery	Lithium 3.7V 1500mAh
Operation Temp Range	0 °C -40°C
IP Rating	IP20
Auto Test	Yes

# EMERGENCY EXIT SIGN

BY-B2036E&BY-B2136E&BY-B2236E



## Features

- » Super bright&Long Lasting LEDs
- » IP65 Protection Rating
- » Multiple legend options available
- » 3 Hour Emergency Duration
- » Maintained/Maintained Optional
- » Recessed & Surface mounting available

## Light Distribution Curve

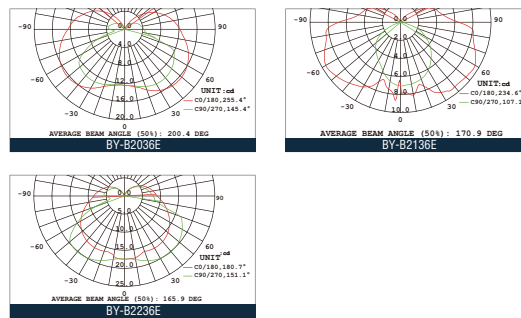

## Product Size

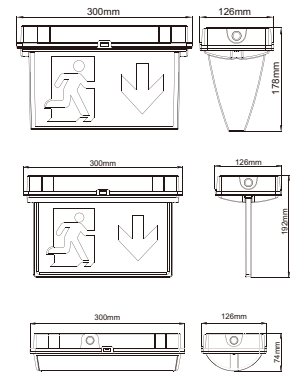

Unit:mm

## Product parameters

MODEL NAME	BY-B2036E	BY-B2136E	BY-B2236E
Input Voltage	AC220-240V, 50/60Hz, 60mA	AC220-240V, 50/60Hz, 60mA	AC220-240V, 50/60Hz, 60mA
Light Source	SMD2835(18pcs)	SMD2835(18pcs)	SMD2835(18pcs)
Input Power	5.5W	5.5W	5.5W
Emergency Power	1.5W	1.5W	1.5W
Operation Mode	Maintained/Non-Maintained	Maintained/Non-Maintained	Maintained/Non-Maintained
Emergency Duration	180 Minutes	180 Minutes	180 Minutes
Emergency Luminance Flux	100lm	50lm	90lm
Recharge Time	16 Hrs	16 Hrs	16 Hrs
Battery	LiFePO4 6.4V, 1500mAh	LiFePO4 6.4V, 1500mAh	LiFePO4 6.4V, 1500mAh
Battery Life	Up to 4 years	Up to 4 years	Up to 4 years
Operation Temp Range	0 °C -40°C	0 °C -40°C	0 °C -40°C
Degree of Protection	IP65	IP65	IP65
Auto Test	Yes	Yes	Yes
Certificate	CE/ENEC/COC-DEKRA	CE/ENEC/COC-DEKRA	CE/ENEC/COC-DEKRA

# EMERGENCY EXIT SIGN

BY-B2108E-S24L-C&BY-B2108E-S32L

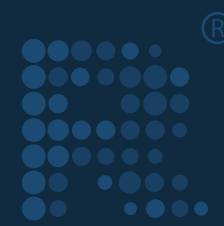

## Features

- » Super bright&Long Lasting LEDs
- » CE Approved
- » Multiple legend options available
- » 3 Hour Emergency Duration
- » Universal Mounting: Wall/Ceiling/Flag/Suspend/Hanging/Recessed Mounting
- » Maintained/Maintained Optional

## Light Distribution Curve

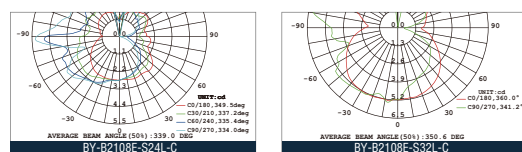

## Product Size

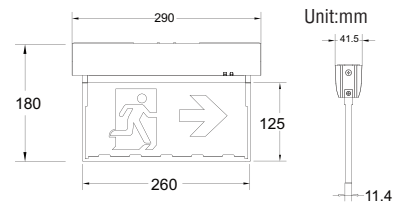

## Different directions (customizable pattern)



## Product parameters

MODEL NAME	BY-B2108E-S24L	BY-B2108E-S32L
Input Voltage	AC220-240V, 50/60Hz, 70mA	AC220-240V, 50/60Hz, 90mA
Light Source	SMD4014(24pcs)	SMD4014(36pcs)
Input Power	5.5W	8W
Emergency Power	1.3W	2.2W
Operation Mode	Maintained/Non-Maintained	Maintained/Non-Maintained
Emergency Duration	180 Minutes	180 Minutes
Emergency Luminance Flux	12lm	24lm
Recharge Time	24 Hrs	24 Hrs
Battery	LiFePO4 3.2V, 1500mAh	LiFePO4 3.2V, 3000mAh
Viewing Distance	24M	32M
Operation Temp Range	0 °C -40°C	0 °C -40°C
Degree of Protection	IP40	IP40
Auto Test	Yes	Yes
Certificate	CE/ENEC/COC-DEKRA	CE/ENEC/COC-DEKRA

# EMERGENCY EXIT SIGN

BY-B2415I20&BY-B2415I21

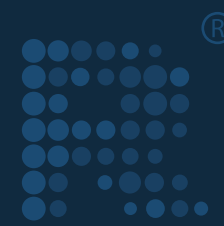

## Features

- » Super bright&Long Lasting LEDs
- » TUV CE & CB Approved
- » Universal Mounting:  
Wall/Ceiling/Flag/Hanging/Recessed Mounting
- » Single or double side with changeable legends
- » Overcharge and Over-discharge protection
- » Auto test function, Maintenance Saving

## Light Distribution Curve

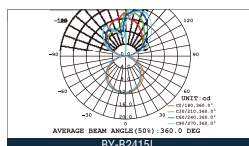

## Product Size

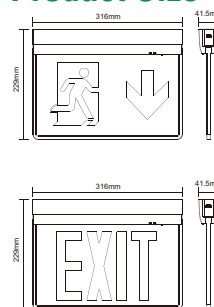

Unit:mm

## Product parameters

MODEL NAME	BY-B2415I20	BY-B2415I21
Input Voltage	AC 220-240V, 50/60 Hz, 50mA	AC 220-240V, 50/60 Hz, 50mA
Light Source	SMD 4014(24pcs)	SMD 4014(24pcs)
Input Power	4.5W	4.5W
Emergency Power	1.5W	1.5W
Operation Mode	Maintained	Maintained
Emergency Duration	3 Hrs	3 Hrs
Emergency Luminance Flux	10Lm	10Lm
Recharge Time	24 Hrs	24 Hrs
Battery	LFP 3.2V 2100mAh	LFP 3.2V 2100mAh
Operation Temp Range	0 °C -40°C	0 °C -40°C
IP Rating	IP20	IP20
Auto Test	Yes	Yes
Certificate	TUV CE & CB	TUV CE & CB

# EMERGENCY CEILING LIGHT

BY-Z3108E&BY-Z1015E&  
BY-Z1018E&BY-Z1024E



## Features

- » Super bright&Long Lasting LEDs
- » TUV CE & CB Approved
- » Test switch and AC-ON indicator included
- » 3 Hour Emergency Duration
- » Overcharge and Over-discharge protection

## Light Distribution Curve

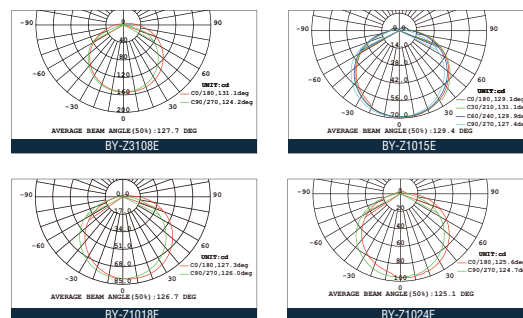

## Product Size

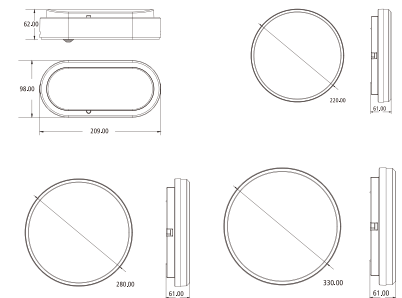

Unit:mm

## Product parameters

MODEL NAME	BY-Z3108E	BY-Z1015E	BY-Z1018E	BY-Z1024E
Input Voltage	AC 220-240V, 50/60 Hz, 100mA	AC 220-240V, 50/60 Hz, 140mA	AC 220-240V, 50/60 Hz, 150mA	AC 220-240V, 50/60 Hz, 180mA
Light Source	SMD 2835(70pcs)	SMD 2835(84pcs)	SMD 2835(96pcs)	SMD 2835(144pcs)
Input Power	8W	15W	18W	24W
Emergency Power	0.8W	1.5W	1.8W	2.5W
Operation Mode	Maintained & Non-Maintain & Swich control	Maintained & Non-Maintain & Swich control	Maintained & Non-Maintain & Swich control	Maintained & Non-Maintain & Swich control
Emergency Duration	3 Hrs	3 Hrs	3 Hrs	3 Hrs
Lumiance Flux	500 Lm	900 Lm	1450 Lm	1650 Lm
Emergency Lumiance Flux	100 Lm	250 Lm	280 Lm	330 Lm
Recharge Time	24 Hrs	24 Hrs	24 Hrs	24 Hrs
Battery	LiFePO4 3.2V 1500mAh	LiFePO4 6.4V 1500mAh	LiFePO4 9.6V 1500mAh	LiFePO4 9.6V 1500mAh
Degree of Protection	IP54	IP65	IP65	IP65
Operation Temp Range	0 °C -40°C	0 °C -40°C	0 °C -40°C	0 °C -40°C
Auto test	No	No	No	No
Certificate	CE & CB-TUV	CE & CB-TUV	CE & CB-TUV	CE & CB-TUV

# TWIN HEAD LIGHT

BY-Z2035C

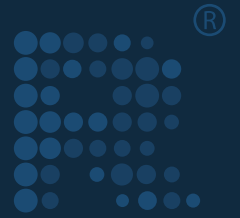

## Features

- » Super bright & Long Lasting LEDs
- » CE Approved
- » Test switch and AC-ON indicator included
- » 3 Hour Emergency Duration
- » Overcharge and Over-discharge protection
- » Non-Maintained Operation Mode

## Light Distribution Curve

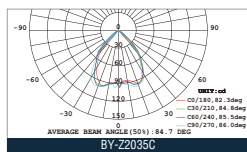

## Product Size

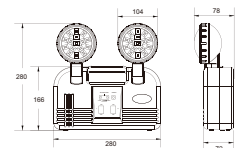

Unit:mm

## Product parameters

MODEL NAME	BY-Z2035C
Input Voltage	AC 220-240V, 50/60 Hz, 30mA
Light Source	SMD 2835(32pcs)
Input Power	2.5W
Operation Mode	Non-Maintained
Emergency Duration	3 Hrs
Emergency Luminance Flux	180 Lm
Recharge Time	24 Hrs
Battery	Lead acid 4.0V 2500mAh
Degree of Protection	IP20
Operation Temp Range	0 °C -40°C
Auto Test	No
Certificate	CE & CB-TUV

# EMERGENCY LIGHT

BY-Z3125A2



## Features

- » Super bright & Long Lasting LEDs
- » CE & CB Approved
- » High / Low level brightness adjustable
- » 3 Hour Emergency Duration
- » Overcharge and Over-discharge protection
- » Power Cable included

## Light Distribution Curve

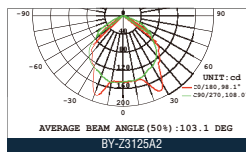

## Product Size

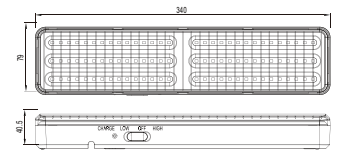

Unit:mm

## Product parameters

MODEL NAME	BY-Z3125A2
Input Voltage	AC 220-240V, 50/60 Hz
Light Source	SMD 2835(90pcs)
Emergency Power	H:3W L:1.4W
Operation Mode	Maintained
Emergency Duration	H: 3 Hrs L: 6Hrs
Emergency Luminance Flux	H:270lm L: 110lm
Recharge Time	24 Hrs
Battery	Lithium 3.7V 1200mAhX2
Degree of Protection	IP20
Operation Temp Range	0 °C -40°C
Auto Test	No
Certificate	CE & CB





**الرووف**  
LIGHTING TECHNOLOGY CO.Ltd.



**شركة الرووف**  
لتقنية الإنارة المحدودة

**Dammam  
Head Office**

Prince Metib St, Izdihar District,  
Alrouf Trading Building,  
Dammam 34252,  
Saudi Arabia.

**Phone: 920013524**  
**sales@alroufled.com**

**JEDDAH**

**Branch Office**

Commercial Centre for  
Dr.Hassan Nasr  
Baladiyah Street,  
Al Aziziyah District.

**Contact person:**  
**Ahmed Faris**

**ABHA**

**Branch Office**

Southern Region,  
Khamis Mushait,  
Kingdom of Saudi Arabia.

**Contact person:**  
**Malik Bashir**

**RIYADH**

**Branch Office**

**Contact person:**  
**Mr. Hasan**

[www.alroufled.com](http://www.alroufled.com)